



**NEW**

# TECHNOLOGY SHOWCASE





**NEW**

# KNOCKOUTS

## NEXT GENERATION OF KNOCKOUTS

Since the day we invented the knockout in 1928, we've made it our mission to build for the world's expert tradespeople. As the industry evolves and technology advances, we continue our 90-year legacy of providing optimal knockout solutions.

- Punch up to 10-gauge mild steel or 12-gauge stainless steel. Also punches aluminum, brass, copper fiberglass and plastics.
- Slug-Buster® punch profile splits slugs for easy slug removal
- Knurled edge on punches for better grip
- New die design optimized for widest range of materials and drivers
- Taller die—no spacers required
- Laser marking for quick part identification
- Die alignment markings for improved punching accuracy
- Easy threading – draw studs with “dog-point” tip helps eliminate cross threading. Hex key access for easy removal from tool
- No sleeves required



### KNOCKOUT UPGRADE SETS

| CAT. NO. | UPC NO.      | DESCRIPTION                                                |
|----------|--------------|------------------------------------------------------------|
| KCC4-LS  | 783310088028 | Slug-Buster® 1/2" to 4" for Battery-Hydraulic Drivers      |
| KCC2-LS  | 783310088004 | Slug-Buster® 1/2" to 2" for Battery-Hydraulic Drivers      |
| KCC4-767 | 783310088011 | Slug-Buster® 1/2" to 4" for Ram and Hand Pump              |
| KCC2-767 | 783310087991 | Slug-Buster® 1/2" to 2" for Ram and Hand Pump              |
| KCC2-QD  | 783310087984 | Slug-Buster® 1/2" to 2" for Quick Draw® and Quick Draw® 90 |

Interested in using your existing Greenlee knockout driver with the new knockouts? Upgrade your knockouts and case to fit your driver.

**NEW**

# KNOCKOUT KITS

## NEXT GENERATION OF KNOCKOUTS



LS100X11SB4

### 11-Ton and 7-Ton Battery-Hydraulic Drivers

- The compact and powerful battery-hydraulic drivers are the fastest, most ergonomic, and versatile knockout solution
- Punch up to 4" conduit-sized holes in mild steel, stainless steel, aluminum, brass, copper, fiberglass, and plastics



7310SB

### 11-Ton Manual-Hydraulic Drivers

- The compact design with 11 tons of punching force is capable of punching up to 4" conduit size holes in 10-gauge mild steel and 12-gauge stainless steel; also punches aluminum, brass, copper, fiberglass and plastics
- The hand pump and foot pump options allow for a variety of operation orientations



7906SB

### 8-Ton Manual-Hydraulic Drivers

- The compact design delivers 8 tons of punching force for portability and fast, easy one-person operation
- Punch 1/2" to 2" conduit size holes in up to 10-gauge mild steel and 12-gauge stainless steel; also cuts aluminum, brass, copper, fiberglass and plastics.
- Available in three driver orientations



7238SB

### Ratchet Kits and Manual Sets

- New and improved high-leverage wrench with five-degree ratcheting mechanism provides versatility and accessibility in tight spaces
- The long, over-mold handle offers greater leverage, comfort and grip
- Punch 1/2" to 2" conduit size holes in 10-gauge mild steel; also punches aluminum, brass, copper, fiberglass and plastics



**NEW**

## BATTERY-HYDRAULIC DRIVERS

Compact, fast, and powerful battery-hydraulic knockout drivers capable of punching up to 6-inch conduit sized holes in mild steel, stainless steel, aluminum, brass, copper, fiberglass and plastics.



LS50L2

**7-TON**

### 7-TON PUNCHING FORCE

Punch up to:  
 4" conduit up to 12 ga mild steel  
 3" conduit up to 10 ga mild steel  
 2" conduit up to 12 ga stainless steel



### AUTO-STOP FEATURE

Detects punch completion and automatically stops, helping to prevent damage to knockout parts



LS100X Intelli-PUNCH™

**11-TON**

### 11-TON PUNCHING FORCE

Punch up to:  
 4" conduit up to 10 ga mild steel  
 4" conduit up to 10 ga stainless steel



### PATENT-PENDING AUTO-RETRACT TECHNOLOGY

Pressure-sensing technology accurately detects punch completion and automatically retracts the ram, helping to prevent damage to knockout parts

### LS100X INTELLI-PUNCH™ 11-TON BATTERY-HYDRAULIC KNOCKOUT KITS

| CAT NO.      | UPC NO.      | DESCRIPTION                                     |
|--------------|--------------|-------------------------------------------------|
| LS100X11SB4  | 783310064848 | Slug-Buster® 1/2" to 4" Conduit                 |
| LS100X11SB4X | 783310064855 | Slug-Buster® 1/2" to 3" and 4" Conduit          |
| LS100X11SB   | 783310064831 | Slug-Buster® 1/2" to 2" Conduit                 |
| LS100X11A    | 783310064824 | Driver, Draw Studs, Batteries, Charger and Case |
| LS100XB      | 783310064817 | Driver and Case Only                            |
| LS100X       | 783310088059 | Driver Only                                     |

### LS50L2 7-TON BATTERY-HYDRAULIC KNOCKOUT KITS

| CAT NO.   | UPC NO.      | DESCRIPTION                                   |
|-----------|--------------|-----------------------------------------------|
| LS50L11B4 | 783310037743 | Slug-Buster® 1/2" to 4" Conduit               |
| LS50L11B  | 783310049562 | Slug-Buster® 1/2" to 2" Conduit               |
| LS50L11A  | 783310049517 | Driver, Draw Studs, Battery, Charger and Case |
| LS50LB    | 783310011316 | Driver and Case Only                          |
| LS50L2    | 783310088042 | Driver Only                                   |



### 360° ROTATING HEAD

Rugged patent-pending swivel design to easily punch at any angle



### TIMESAVER

Punch faster, with a maximum cycle time of 8 seconds



### COMPACT, ERGONOMIC DESIGN

Provides easy one-handed operation and an ergonomic tapered grip



### COMPATIBILITY

Works with all Greenlee knockouts and other major brands designed for use with a hydraulic tool. Same draw studs used with the Intelli-PUNCH, LS50 and 746 ram



### BATTERY PLATFORM

Powerful long-lasting Makita® 18V Li-Ion battery, quickly charges in 30 minutes



**NEW**

# PUSHBUTTON OILTIGHT KNOCKOUTS

THE OPTIMAL SOLUTION FOR STAINLESS STEEL

**Specialized Knockout**

Punch and notch in one easy step for fast pushbutton (oiltight) installation

**New Die Design**

Optimized depth for widest range of materials and drivers



KS-PB30

**Easy Assembly**

Designed for use with any Greenlee hydraulic driver – no adapters required

**Durable, High Grade Steel**

Provides maximum life in mild and stainless steel



KS-PB30

**SPECIFICATIONS**

|                            |                                           |
|----------------------------|-------------------------------------------|
| Minimum Pilot Hole Size    | 0.625"                                    |
| Maximum Material Thickness | 12 ga Stainless Steel<br>10 ga Mild Steel |

| PUSHBUTTON KNOCKOUT SET | UPC NO.      | SIZE    | PUNCH   | DIE     | DRAW-STUD | NUT    |
|-------------------------|--------------|---------|---------|---------|-----------|--------|
| KS-PB22                 | 783310044352 | 22.5 mm | KP-PB22 | KD-PB22 | DSPB      | 04445G |
| KS-PB30                 | 783310044369 | 30.5 mm | KP-PB30 | KD-PB30 |           |        |



**NEW**

# CARBIDE CUTTERS

THE OPTIMAL SOLUTION FOR DRILLING IN STAINLESS STEEL



625-4-1-2

**Split-Point Cobalt Steel Pilot Drill with Step Design**

For fast, accurate cutting with less force

**Tungsten Carbide Teeth**

Optimized design for fast, easy cutting and maximum life in stainless steel – no oil required. Easily cut burr-free holes with less force.

**Flange Stop**

Eliminates over-drilling

**Slug Ejector Spring**

Quick, easy slug removal



645-4-1-2

645-022 Quick-Change Arbor Sold Separately

## One-Piece Carbide-Tipped Hole Cutters

- Strong, durable one-piece construction for even longer life
- Available in 2 sets and 14 sizes ranging from 3/4" to 4-1/2".



628

## Quick-Change Carbide-Tipped Hole Cutters

- Switch quickly between cutter sizes without re-chucking with a simple push and turn connection
- Available in 3 sets and 25 sizes ranging from 5/8" to 4-1/2".



648

| CAT NO. | UPC NO.      | DESCRIPTION                                                                       |
|---------|--------------|-----------------------------------------------------------------------------------|
| 628     | 783310064008 | 7/8", 1-1/8", 1-3/8", 1-3/4", 2", 2-1/2" cutters, pilot drills, hex keys and case |
| 635     | 783310035992 | 7/8", 1-1/8", 1-3/8" cutters, pilot drills, hex key and case                      |

| CAT NO. | UPC NO.      | DESCRIPTION                                                                                   |
|---------|--------------|-----------------------------------------------------------------------------------------------|
| 648     | 783310064015 | 7/8", 1-1/8", 1-3/8", 1-3/4", 2", 2-1/2" cutters, small arbor, large arbor, hex keys and case |
| 660     | 783310057666 | 7/8", 1-1/8", 1-3/8", 1-3/4" cutters, small arbor, hex key and case                           |
| 655     | 783310058205 | 7/8", 1-1/8", 1-3/8" cutters, small arbor, hex key and case                                   |



**NEW**

## DRILL/TAP BITS OPTIMIZED FOR STAINLESS STEEL

### Strong, High-Speed Steel

Superior heat and abrasion resistance for maximum performance in stainless steel

### Optimized Core

Reduces torque and extends bit life

### Split-Point Tip

Penetrates faster and prevents walking while drilling



### Titanium Nitride Coating

Runs cooler, drills faster, and lasts longer

### Longer Bit

Drill in up to 1/4" thick material

#### STANDARD

| CAT. NO.      | SIZE           | DESCRIPTION                                                              |
|---------------|----------------|--------------------------------------------------------------------------|
| DTAPSSKIT     | 6-32 to 1/4-20 | Standard Kit, 7-piece Drill/Tap Bit Kit with Quick-Change Adapter & Case |
| DTAPSS6-32    | 6-32           | 6-32 Drill/Tap Bit                                                       |
| DTAPSS8-32    | 8-32           | 8-32 Drill/Tap Bit                                                       |
| DTAPSS10-24   | 10-24          | 10-24 Drill/Tap Bit                                                      |
| DTAPSS10-32   | 10-32          | 10-32 Drill/Tap Bit                                                      |
| DTAPSS12-24   | 12-24          | 12-24 Drill/Tap Bit                                                      |
| DTAPSS1/4-20  | 1/4-20         | 1/4-20 Drill/Tap Bit                                                     |
| DTAPSS5/16-18 | 5/16-18        | 5/16-18 Drill/Tap Bit                                                    |
| DTAPSS3/8-16  | 3/8-16         | 3/8-16 Drill/Tap Bit                                                     |

#### METRIC

| CAT. NO.   | SIZE      | DESCRIPTION                                                            |
|------------|-----------|------------------------------------------------------------------------|
| DTAPSSKITM | M3 to M10 | Metric Kit, 7-piece Drill/Tap Bit Kit with Quick-Change Adapter & Case |
| DTAPSSM3C  | M3        | M3 x 0.5 Drill/Tap Bit                                                 |
| DTAPSSM4C  | M4        | M4 x 0.7 Drill/Tap Bit                                                 |
| DTAPSSM5C  | M5        | M5 x 0.8 Drill/Tap Bit                                                 |
| DTAPSSM6C  | M6        | M6 x 1.0 Drill/Tap Bit                                                 |
| DTAPSSM8C  | M8        | M8 x 1.25 Drill/Tap Bit                                                |
| DTAPSSM10C | M10       | M10 x 1.50 Drill/Tap Bit                                               |

#### SPECIFICATIONS

|                            |                                                                               |
|----------------------------|-------------------------------------------------------------------------------|
| Rated for                  | Stainless steel, mild steel, aluminum, brass, copper, fiberglass and plastics |
| Maximum Material Thickness | Up to 1/4" thick material (3 gauge)                                           |

#### TIPS FOR OPTIMAL PERFORMANCE

- Use with 18V battery drills and similar or larger sizes
- Use low setting on battery drill
- Use cutting oil when drilling and tapping all stainless steel material for extended tool life

#### SETS INCLUDE

- Durable case for convenient bit storage
- Quick-change adapter



Also available in individual sizes.



**NEW**

# PROFESSIONAL TOOL BACKPACK

EXTREME COMFORT. EASY TOOL ORGANIZATION.

**Thermoformed Molded Safety Pocket**  
Keep safety glasses and other small valuables protected in the work environment

**Personalized Name Plate\***  
Customize your bag with a personalized embroidered name plate  
(See hang tag for instructions)



**2 Separate Zippered Compartments**  
For easier tool organization – second zippered compartment allows for easy storage of power drill, batteries, chargers, etc.

**Large Supported Front Pocket**  
Conveniently carries fish tape or hard hat

**High Visibility Reflective Piping**  
Helps locate your tool bag in dark work spaces

**Poly & Nylon Ripstop Construction**  
Makes for a durable, long lasting and lightweight bag

**Impact Resistant Waterproof Plastic Bottom**  
Keeps tools and bag protected from the elements



**Formed Steel Hanging Hook**  
Hang your bag for easy access



**S-Strap Shoulder Strap**  
Ergonomically designed, fit to distribute weight evenly

**Padded Lumbar Support**  
Reduces back strain when carrying a loaded backpack

**30 Universal Double Stitched Pockets**  
Heavy-duty pockets for ultimate tool storage and organization



**Green Interior**  
Easy tool visibility in dark work spaces





**NEW**



**Professional Tool Backpack\***  
0158-26



**Professional Tool & Tech Backpack\***  
0158-27



**20" Heavy-Duty Multi-Pocket Tool Bag**  
0158-21



**18" Heavy-Duty Multi-Pocket Tool Bag**  
0158-22



**16" Heavy-Duty Open Tool Tote**  
0158-25



**11" Electrician's Open Tool Carrier**  
0158-24



**11" Heavy-Duty Open Tool Carrier\***  
0158-29



**Crate Cover Tool Organizer\*\***  
0158-28



| CAT. NO. | UPC NO.      | DESCRIPTION                        |
|----------|--------------|------------------------------------|
| 0158-26  | 783310064060 | Backpack, Professional Tool        |
| 0158-27  | 783310064077 | Backpack, Professional Tool & Tech |
| 0158-21  | 783310064084 | Tool Bag, Multi-Pocket HD 20"      |
| 0158-22  | 783310064091 | Tool Bag, Multi-Pocket HD 18"      |

| CAT. NO. | UPC NO.      | DESCRIPTION                         |
|----------|--------------|-------------------------------------|
| 0158-25  | 783310064107 | Tool Tote, Heavy Duty Open 16"      |
| 0158-24  | 783310064114 | Tool Carrier, Electricians Open 11" |
| 0158-29  | 783310073833 | Carrier, 11" Heavy Duty Open Tool   |
| 0158-28  | 783310073826 | Cover, Crate Tool Organizer         |

\*The Professional Tool Backpack (0158-26), Professional Tool & Tech Backpack (0158-27) and 11" Heavy-Duty Open Tool Carrier (0158-29) receive a personalized embroidered name plate. Visit [www.greenlee.com/toolbagregistration.com](http://www.greenlee.com/toolbagregistration.com) for more details.

\*\*Crate not included.



**NEW**

# PVC SHEARS

## EASIER CUTTING WITH LESS FORCE

### Average Handle Force\* (LBS)

Cutting 1-5/8" O.D. Schedule 40 PVC

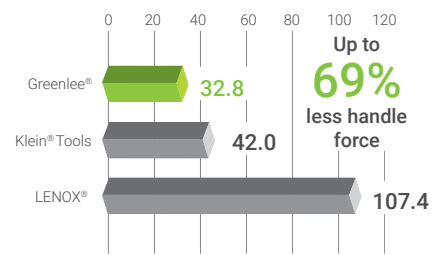

#### Replaceable Blade

Effortlessly replace the blade without tools or loose parts

#### Square Jaw

Easily squares up all ranges of pipe sizes to ensure a straight cut

#### Blade Release Lever

Quickly retract the blade with the push of a lever for one-handed operation

#### Dial Handle Lock

Located at the top of tool to prevent accidental locking

#### Ergonomic Design

Reduced hand force during operation

#### Molded Grip

Slip-proof, ergonomically molded grips for increased comfort and reduced fatigue



864QR

### SPECIFICATIONS

|                  |                   |
|------------------|-------------------|
| Cutting Capacity | 1-5/8" O.D. PVC   |
| Length           | 9"                |
| Width            | 5"                |
| Weight           | 1.35 lb (0.61 kg) |

| CAT. NO. | UPC NO.      | DESCRIPTION               |
|----------|--------------|---------------------------|
| 864QR    | 783310080428 | PVC Cutter                |
| 864QRBL  | 783310079798 | Blade Replacement (864QR) |

\*Results determined through external testing comparing the Greenlee® 864QR, Klein® (Cat. No. 50031), and LENOX® R1 (Cat. No. 12123R1) cutters based on cutting 1-5/8" O.D. Schedule 40 PVC. Field results may vary depending on diameter and type of PVC cut.

Klein® is a registered trademark of Klein® Tools, Inc.  
Lenox® is a registered trademark of Irwin Industrial Tool Company.



**NEW**

# HIGH LEVERAGE PLIERS

GREATER CUTTING POWER. STRONGER HOLD.



**Toothed Pipe Grip**  
Provides strong hold on rounded material

**Versatility**  
Versatile jaw design for use on flat or rounded material

**High Leverage Handle Design**  
Provides greater cutting power than standard plier design



**Forged from Chrome Vanadium Steel**  
For greater strength and long life of the plier

**Ease of Use**  
Double-dipped vinyl handle grips provide comfort and slip resistance

### SPECIFICATIONS

|                           |        |
|---------------------------|--------|
| Grip Length               | 9"     |
| Grip Type                 | Dipped |
| Overall Length (in)       | 9.013  |
| Exposed Plier Length (in) | 3.126  |
| Handle Length (in)        | 5.887  |
| Handle Width (in)         | 2.051  |
| Handle Thickness (in)     | 0.646  |

## 9" HIGH LEVERAGE SIDE CUTTING PLIERS WITH PIPE GRIP

0151-09HD

| CAT. NO.  | UPC NO.      | DESCRIPTION                                      |
|-----------|--------------|--------------------------------------------------|
| 0151-09HD | 783310083788 | 9" High Leverage Side Cutting Pliers w/Pipe Grip |



**NEW**

# ADJUSTABLE TORQUE DRIVER

MAXIMIZED ACCURACY. INCREASED PROTECTION.



**Major Graduation Display**  
Torque range: 5-40 in lb

**Adjustable Knob**  
Easily set torque value

**Calibrated**  
Within tolerance according to:  
ASME B107.300-2010  
(certificate included)

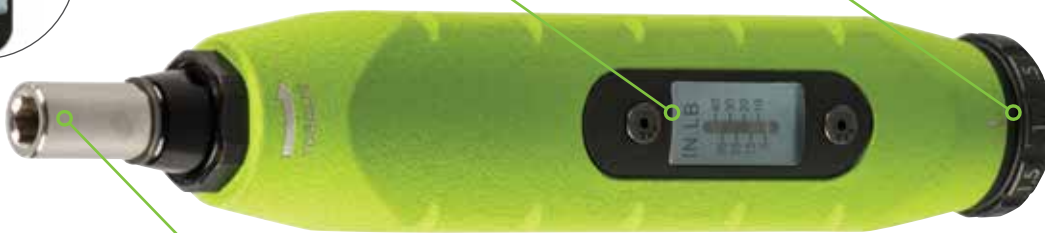

1/4" female hex drive magnetically holds bits and sockets

0153-46T

**Accuracy**

- Ensures connections are tightened to the correct torque rating, eliminating the need for guesswork

**Compliance**

- Sufficiently tightens connections to comply with new 2017 National Electric Code (110.14D)
- Helps prevent fires and other hazards caused by improperly torqued connections

**Protection**

- Durable, compact case provides optimal tool protection

**Case**

- EVA foam-molded case provides increased cushioning, resilience, and durability while keeping contents inside secure
- Bit sizes are printed inside the case for easy identification and selection



**SPECIFICATIONS**

|                       |                                                                                                               |                                                                                                                                       |
|-----------------------|---------------------------------------------------------------------------------------------------------------|---------------------------------------------------------------------------------------------------------------------------------------|
| <b>Torque Range</b>   | 5-40 in lb                                                                                                    |                                                                                                                                       |
| <b>Overall Length</b> | 6 3/4"                                                                                                        |                                                                                                                                       |
| <b>Shank Length</b>   | 11/16"                                                                                                        |                                                                                                                                       |
| <b>Handle Length</b>  | 6"                                                                                                            |                                                                                                                                       |
| <b>Bits</b>           | Phillips #1 x 6"<br>Phillips #2 x 6"<br>Flat 3/16" x 6"<br>Flat 1/4" x 6"<br>Square #1 x 6"<br>Square #2 x 6" | Phillips #1 x 3 1/2"<br>Phillips #2 x 3 1/2"<br>Flat 3/16" x 3 1/2"<br>Flat 1/4" x 3 1/2"<br>Square #1 x 3 1/2"<br>Square #2 x 3 1/2" |
| <b>Sockets:</b>       | Nut Driver 3/16"-6"<br>Nut Driver 1/4"-6"<br>Nut Driver 5/16"-6"<br>Nut Driver 11/32"-6"                      | Nut Driver 3/8"-6"<br>Nut Driver 7/16"-6"<br>Nut Driver 1/2"-6"                                                                       |

| CAT. NO.    | UPC NO.      | DESCRIPTION                          |
|-------------|--------------|--------------------------------------|
| 0153-46T    | 783310083603 | Torque Screwdriver & Bit Set         |
| 9953-46T    | 783310083597 | Replacement Bit Kit                  |
| 0153-46CASE | 783310090694 | Case, Replacement Torque Screwdriver |



**NEW**

# 11-IN-1 MULTI-DRIVER

## MULTI-FUNCTIONAL SCREWDRIVER & NUTDRIVER



Bits are quickly and easily swapped out



Bits are stored inside the shank



0153-47C



Square Recess #1 & #2

Phillips #2 & Slotted 1/4"

Torx® #10 & #15

Phillips #1 & Slotted 3/16"



1/4" Nutdrivers

### SPECIFICATIONS

|                |                                                                   |                                                                  |
|----------------|-------------------------------------------------------------------|------------------------------------------------------------------|
| Overall Length | 7.94"                                                             |                                                                  |
| Shank Length   | 1.97"                                                             |                                                                  |
| Handle Length  | 4.92"                                                             |                                                                  |
| Bits           | Phillips #1<br>Flat 3/16"<br>Square #1<br>Phillips #1<br>Torx #10 | Phillips #2<br>Flat 1/4"<br>Square #2<br>Phillips #2<br>Torx #15 |
| Sockets        | Nut Driver 1/4"<br>Nut Driver 5/16"<br>Nut Driver 3/8"            |                                                                  |

| CAT. NO. | UPC NO.      | DESCRIPTION          |
|----------|--------------|----------------------|
| 0153-47C | 783310083634 | Multi-Tool, 11-in-1  |
| 9953-20  | 783310083641 | Bit Set, Replacement |

Torx is a registered trademark of ACUMENT INTELLECTUAL PROPERTIES, LLC



**NEW**

# MAGNETIC TIP NUT DRIVERS

STRONGER HOLD FOR EASIER OPERATION

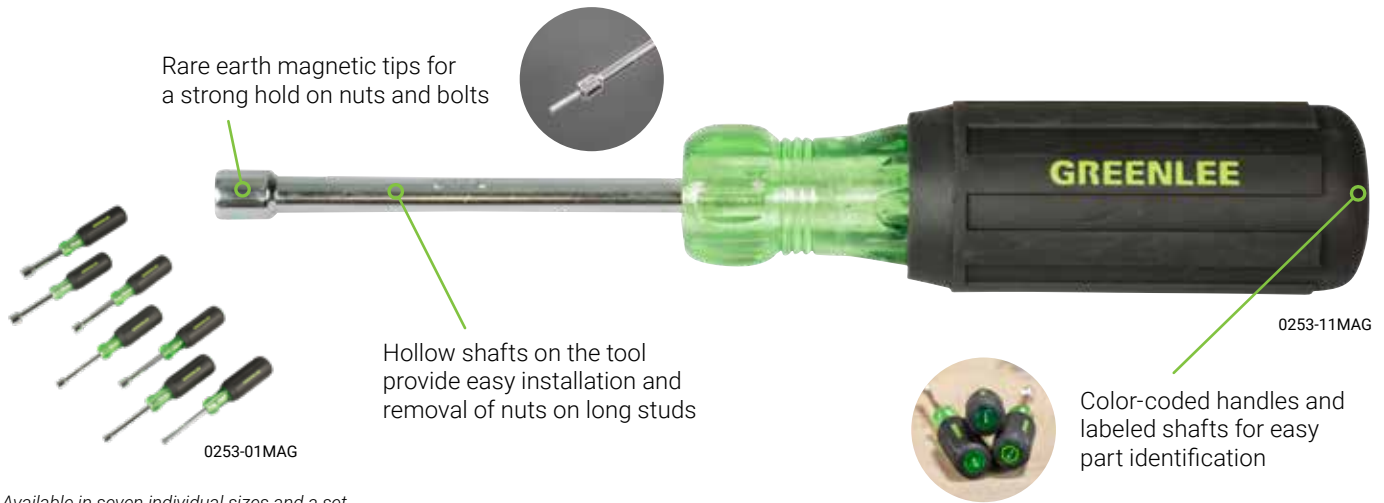

Available in seven individual sizes and a set

| SPECIFICATIONS |                                                                            |                                                          |
|----------------|----------------------------------------------------------------------------|----------------------------------------------------------|
| Overall Length | 7.94"                                                                      |                                                          |
| Shank Length   | 1.97"                                                                      |                                                          |
| Handle Length  | 4.92"                                                                      |                                                          |
| Sockets        | Nut Driver 3/16"<br>Nut Driver 5/16"<br>Nut Driver 3/8"<br>Nut Driver 1/2" | Nut Driver 1/4"<br>Nut Driver 11/32"<br>Nut Driver 7/16" |

| CAT. NO.   | UPC NO.      | DESCRIPTION                      |
|------------|--------------|----------------------------------|
| 0253-01MAG | 783310083375 | 7-Piece Nut Driver Set           |
| 0253-11MAG | 783310083306 | Nutdriver, Magnetic, 3/16" x 3"  |
| 0253-12MAG | 783310083313 | Nutdriver, Magnetic, 1/4" x 3"   |
| 0253-13MAG | 783310083320 | Nutdriver, Magnetic, 5/16" x 3"  |
| 0253-14MAG | 783310083337 | Nutdriver, Magnetic, 11/32" x 3" |
| 0253-15MAG | 783310083344 | Nutdriver, Magnetic, 3/8" x 3"   |
| 0253-16MAG | 783310083351 | Nutdriver, Magnetic, 7/16" x 3"  |
| 0253-17MAG | 783310083368 | Nutdriver, Magnetic, 1/2" x 3"   |



**NEW**

# WATER PUMP PLIERS

MAXIMUM GRIP. QUICK JAW-ADJUSTMENTS.



**Push-Button Design**

Provides quick and easy jaw adjustments



**Multi-Functional**

Multi-purpose jaws for strong grip on round, flat, square or hex materials

**Rhombus-Shaped Jaw**

With opposing offset teeth ensure maximum grip on rounded material



0451-10WD

**Precision Jaw Adjustment**

Quickly and easily adapt to a wide range of sizes



**Water Pump Plier Set**

Available in sizes 8", 10", 12" and a 3-piece set

**SPECIFICATIONS**

|                           | 8" WATER PUMP PLIERS | 10" WATER PUMP PLIERS | 12" WATER PUMP PLIERS |
|---------------------------|----------------------|-----------------------|-----------------------|
| Overall Length (in)       | 8.09                 | 10.02                 | 12.23                 |
| Exposed Plier Length (in) | 3.493                | 4.331                 | 5.277                 |
| Handle Length (in)        | 4.597                | 5.689                 | 6.953                 |
| Handle Width (in)         | 1.99                 | 2.29                  | 2.29                  |
| Handle Thickness (in)     | 0.567                | 0.567                 | 0.567                 |
| Grip Type                 | Double-Dipped Vinyl  | Double-Dipped Vinyl   | Double-Dipped Vinyl   |

| CAT. NO.  | UPC NO.      | DESCRIPTION                         |
|-----------|--------------|-------------------------------------|
| 0451-08WD | 783310083849 | 8" Push Button Water Pump Pliers    |
| 0451-10WD | 783310083856 | 10" Push Button Water Pump Pliers   |
| 0451-12WD | 783310083863 | 12" Push Button Water Pump Pliers   |
| 0451-01WD | 783310085980 | Water Pump Plier Set (8", 10", 12") |



**NEW**

# G6 TURBO™ 6,000 LB TUGGER

HANDS DOWN FASTER. PERIOD.

**No Loose Pieces**  
Allowing quick changeover for easy transport

**Patent-Pending Adjustable Clamp**  
Secures conduit in seconds without any adapters

**Ergonomic Design**  
Eliminates heavy lifting during setup

**Circuit Breaker Monitor**  
Auto shutoff and extends motor life

**Dual Capstans**  
Increase pulling speeds and maximize efficiency

**Two-Speed Motor**  
Specially designed for 6,000 lb load

**Built-In Dolly**  
Fast and easy transport

**Force Indicator**  
Also helps prevent damage to puller

G6



**SPECIFICATIONS**

|                                        |                                                                                                        |
|----------------------------------------|--------------------------------------------------------------------------------------------------------|
| <b>Pulling Force</b>                   | 4,000 lb (17.800 KN) Continuous<br>5,000 lb (22.200 KN) Intermittent<br>6,000 lb (26.700 KN) Momentary |
| <b>Rope Size</b>                       | 3/4" (19.100 mm) Double-Braided Composite, Rated at 26,000 lb (115.600 kN)                             |
| <b>Drive Motor</b>                     | 120V VAC, 50/60 Hz, 12 Amps                                                                            |
| <b>No Load Main Capstan Speed</b>      | High Speed 28 ft/min (8.53 m/min)<br>Low Speed 11 ft/min (3.35 m/min)                                  |
| <b>No Load Secondary Capstan Speed</b> | High Speed 90 ft/min (27.43 m/min)<br>Low Speed 35 ft/min (10.70 m/min)                                |
| <b>Standard Boom Extension</b>         | 7.5' (2.29 m)                                                                                          |
| <b>Weight</b>                          | 252 lb (114 kg)                                                                                        |

*Includes a force indicator and foot switch*



**G6 Floor Mount**  
Provides ultimate flexibility during a pull in hard to reach areas by allowing for custom set-ups that can create longer tail lengths

| CAT. NO. | UPC NO.      | DESCRIPTION                                        |
|----------|--------------|----------------------------------------------------|
| G6       | 783310069546 | G6 Turbo™ 6,000-pound Puller with Boom/Dolly Mount |
| G6-F     | 783310086314 | G6 Turbo™ 6,000-pound Puller with Floor Mount      |
| 08632    | 783310086321 | Floor Mount Assembly for G6 Turbo™                 |





**NEW**

# K09-SYNCRO AND K05-SYNCRO

## ULTIMATE PRODUCTIVITY



**Color-Coded Die Selection Wheel**  
Quick and easy die selection increases operator efficiency



**Locking Extendable Handles**  
Improve maneuverability and leverage (K09 only)



**Ergonomic Molded Grips**  
Improved comfortable grip

**SYNCRO Die Design**

One-handed die change rotates both dies simultaneously and prevents misalignment of dies



**Versatility**

UL and cUL Classified to seven major brands of lugs and connectors\*



K09-SYNCRO



K05-SYNCRO

### The SYNCRO Crimper Family

| SPECIFICATIONS (K09-SYNCRO) |                    |
|-----------------------------|--------------------|
| Capacity                    | 1 AWG to 250 kcmil |
| Length                      | 23.62" – 29.52"    |
| Weight                      | 5.7 lb (2.6 kg)    |

| SPECIFICATIONS (K05-SYNCRO) |                  |
|-----------------------------|------------------|
| Crimping Range              | 8 to 1/0 AWG     |
| Length                      | 16"              |
| Weight                      | 2.6 lb (1.18 kg) |

| CAT. NO.   | UPC NO.      | DESCRIPTION                     |
|------------|--------------|---------------------------------|
| K09-SYNCRO | 783310064411 | Crimping Tool (8 AWG–250 kcmil) |
| K05-SYNCRO | 783310064404 | Crimping Tool (8 AWG–1/0 AWG)   |

*UL and cUL classified with Anderson®, Blackburn®, Burndy®, ILSCO®, Panduit®, Thomas & Betts® and Penn-Union® copper connectors.*



**NEW**

## GATOR® INSULATED SERIES

SAFETY IS A CHOICE. GET INSULATED.



### BRUSH-GUARDED HEAD

Helps avoid accidental contact with conductors



### TRI-INSULATION BARRIER

Provides three (3) layers of protection (Patent Pending)

### DOUBLE-TAP SAFETY FEATURE OPTION

Prevents unintentional operation

### ULTIMATE DURABILITY

Enclosed, impact-resistant, housing and coated circuit boards protect against water and dirt



### 360° ROTATING HEAD

For improved agility in confined work spaces

### TACKY GRIP

Gripping the tools is easier and more comfortable



### BLUETOOTH® COMMUNICATION

Connects with Greenlee i-press® App



ES20HVX

## IMPROVED SAFETY

The new Greenlee Gator® Insulated Series battery- powered hydraulic cutting and crimping tools feature a patent-pending design to help protect operators from electrical shock up to 1000V.

- Tri-Insulation Barrier impedes voltage from discharging between the head and tool body
- Lower the operators level of movement and exertion, improving precision and safety in confined working conditions



All tools include a high capacity Makita® 18V LXT Li-Ion 4.0Ah battery. Makita and LXT are registered trademarks of MAKITA CORPORATION.

The Bluetooth® word mark is a registered trademark owned by Bluetooth SIG, Inc.

## INSULATED CRIMPING TOOLS



### 6-TON IN-LINE CRIMPERS

| CAT NO.    | UPC NO.      | DESCRIPTION                                                     |
|------------|--------------|-----------------------------------------------------------------|
| EK6IDCVX11 | 783310042624 | 6-Ton Crimper, (PVC) 6ID Jaw, 120V Charger, Two 4.0Ah Batteries |
| EK6IDCVXB  | 783310042662 | 6-Ton Crimper, (PVC) 6ID Jaw, Bare Tool Only                    |
| EK622CVX11 | 783310041030 | 6-Ton Crimper, 622 Jaw, 120V Charger, Two 4.0Ah Batteries       |
| EK622CVXB  | 783310041061 | 6-Ton Crimper, 622 Jaw, Bare Tool Only                          |
| EK628VX11  | 783310042549 | 6-Ton Crimper, CJ22 Jaw, 120V Charger, Two 4.0Ah Batteries      |
| EK628VXB   | 783310042617 | 6-Ton Crimper, CJ22 Jaw, Bare Tool Only                         |
| EK425VXD11 | 783310042129 | 6-Ton Crimper, CJD3 Jaw, 120V Charger, Two 4.0Ah Batteries      |
| EK425VXDB  | 783310042150 | 6-Ton Crimper, CJD3 Jaw, Bare Tool Only                         |

**NOTE:** Connections are UL and cUL classified for copper and aluminum, when used with Greenlee tools on Anderson®, Blackburn®, Burndy®, ILSCO®, Panduit®, Thomas & Betts® and Penn-Union® Color-Coded Lugs and Splices.



## INSULATED CUTTING TOOLS



### IN-LINE CUTTERS

| CAT NO.    | UPC NO.      | DESCRIPTION                                           |
|------------|--------------|-------------------------------------------------------|
| ESC50HVX11 | 783310038160 | 50 mm Cutter, (PVC) 120V Charger, Two 4.0Ah Batteries |
| ESC50HVXB  | 783310038191 | 50 mm Cutter, (PVC) Bare Tool Only                    |
| ESC35HVX11 | 783310038122 | 35 mm Cutter, (PVC) 120V Charger, Two 4.0Ah Batteries |
| ESC35HVXB  | 783310038153 | 35 mm Cutter, (PVC) Bare Tool Only                    |
| ES32HVX11  | 783310038085 | 32 mm Cutter, (PVC) 120V Charger, Two 4.0Ah Batteries |
| ES32HVXB   | 783310038115 | 32 mm Cutter, (PVC) Bare Tool Only                    |
| ESC25HVX11 | 783310040538 | 25 mm Cutter, (PVC) 120V Charger, Two 4.0Ah Batteries |
| ESC25HVXB  | 783310040569 | 25 mm Cutter, (PVC) Bare Tool Only                    |
| ES20HVX11  | 783310040491 | 20 mm Cutter, (PVC) 120V Charger, Two 4.0Ah Batteries |
| ES20HVXB   | 783310040521 | 20 mm Cutter, (PVC) Bare Tool Only                    |



All tools include a high capacity Makita® 18V LXT Li-Ion 4.0Ah battery. Makita and LXT are registered trademarks of MAKITA CORPORATION. The Bluetooth® word mark is a registered trademark owned by Bluetooth SIG, Inc.



**NEW**

## EK6ATILX & EK6FTILX

### IN-LINE QUAD POINT INDENTER

**Open-Face Head**

Designed for quick loading

**New In-Line Design**

Reduces weight by 25% and improves reach of the tool vs. previous pistol design

**Bluetooth® Communication**

Connect with i-Press® App to track tool performance



EK6ATILX

EK6FTILX

**Flip-Top Head**

Designed for higher crimping capacity

**Intelli-CRIMP®**

Monitors each cycle to ensure crimping force is achieved

**Improved Durability**

Enclosed, impact-resistant, housing and coated circuit boards help protect against water and dirt

**Makita® Battery Platform**

18V Li-Ion 4.0Ah battery provides more cycles per charge and charges in under 45 minutes

| CAT NO.    | UPC NO.      | DESCRIPTION                                                            |
|------------|--------------|------------------------------------------------------------------------|
| EK6ATILX11 | 783310084686 | 6-Ton Quad Point Crimper, Open Face, 120V Charger, Two 4.0Ah Batteries |
| EK6ATILX12 | 783310084693 | 6-Ton Quad Point Crimper, Open Face, 12V Charger, Two 4.0Ah Batteries  |
| EK6ATILX22 | 783310084709 | 6-Ton Quad Point Crimper, Open Face, 230V Charger, Two 4.0Ah Batteries |
| EK6ATILXB  | 783310085904 | 6-Ton Quad Point Crimper, Open Face, Bare Tool Only                    |
| EK6FTILX11 | 783310085911 | 6-Ton Quad Point Crimper, Flip Top, 120V Charger, Two 4.0Ah Batteries  |
| EK6FTILX12 | 783310085928 | 6-Ton Quad Point Crimper, Flip Top, 12V Charger, Two 4.0Ah Batteries   |
| EK6FTILX22 | 783310085935 | 6-Ton Quad Point Crimper, Flip Top, 230V Charger, Two 4.0Ah Batteries  |
| EK6FTILXB  | 783310085942 | 6-Ton Quad Point Crimper, Flip Top, Bare Tool Only                     |

**CAPACITY**

|                  |                                                          |
|------------------|----------------------------------------------------------|
| <b>Open Face</b> | Copper: 6 AWG – 500 kcmil<br>Aluminum: 6 AWG – 400 kcmil |
| <b>Flip-top</b>  | Copper: 6 AWG – 750 kcmil<br>Aluminum: 6 AWG – 750 kcmil |

**SPECIFICATIONS**

|                       |                   |
|-----------------------|-------------------|
| <b>Crimping Force</b> | 12,400 lb (55 kN) |
| <b>Height</b>         | 19.5" (495 mm)    |
| <b>Weight</b>         | 8.2 lb (3.75 kg)  |
| <b>Battery</b>        | 18V 4.0Ah Li-ion  |
| <b>Head Rotation</b>  | 360°              |



**NEW**

# EK6IDCLX

## 6 TON UNDERGROUND INDENTING CRIMPER

### Coated Head Brush Guard

Helps avoid accidental contact with conductors

### Dieless Crimping

Simplifying the jobsite, reducing the risk of mismatched dies

### Bluetooth® Communication

Connect with i-press® App to track tool performance

### Makita® Battery Platform

18V Li-Ion 4.0Ah battery provides more cycles per charge and charges in under 45 minutes

### Flip Top Head

Compact design allows for efficiency on the jobsite, ideal for enclosed working conditions

### Dual Stage Telescopic Cylinder

Intelligent fast crimping speed

### Tacky Grip

Gripping the tool is easier and more comfortable

### Improved Durability

Enclosed, impact-resistant, housing and coated circuit boards protect against water and dirt



EK6IDCLX



**DIELESS**

### SPECIFICATIONS

|                            |                                                                                                                                                                                                                                    |
|----------------------------|------------------------------------------------------------------------------------------------------------------------------------------------------------------------------------------------------------------------------------|
| <b>Crimping Force</b>      | Variable 6-Ton (30-60kN)                                                                                                                                                                                                           |
| <b>Head Rotation</b>       | 350°                                                                                                                                                                                                                               |
| <b>Weight with Battery</b> | 5.5 lb (2.5 kg)                                                                                                                                                                                                                    |
| <b>Height</b>              | 15" (380 mm)                                                                                                                                                                                                                       |
| <b>Capacity</b>            | Standard Strand Wire Classes – B; C Copper: #8 – 500 kcmil (MCM)<br>Aluminum: 1/0 – 350 kcmil (MCM)<br>Fine Strand – Copper Wire Classes – G; H; I; K; M: 1/0 – 350 kcmil (MCM)<br>DLO – Copper Locomotive: #8 – 373.7 kcmil (MCM) |

| CAT NO.    | UPC NO.      | DESCRIPTION                                                |
|------------|--------------|------------------------------------------------------------|
| EK6IDCLX11 | 783310080558 | 6-Ton, Dieless Crimper, 120V Charger, Two 4.0 Ah Batteries |
| EK6IDCLX12 | 783310085959 | 6-Ton, Dieless Crimper, 12V Charger, Two 4.0 Ah Batteries  |
| EK6IDCLX22 | 783310085966 | 6-Ton, Dieless Crimper, 230V Charger, Two 4.0 Ah Batteries |
| EK6IDCLXB  | 783310080541 | 6-Ton, Dieless Crimper, Bare Tool Only                     |

Makita® is a registered trademark of Makita Corporation.  
Bluetooth® is a registered trademark of Bluetooth SIG



**NEW**

# ESC50LX – IN-LINE 2" CABLE CUTTER

## NEW CUTTING SOLUTIONS FOR YOUR CHANGING NEEDS

**Hardened Blade**

Produce clean, smooth cuts in Cu/Al cable

**Single Trigger**

Controls all tool functions

**Double-Click Safety Feature**

Helps prevent unintentional engaging cutting blades

**Improved Durability**

Enclosed housing and coated circuit boards protect against water and dirt

**Makita® Battery Platform**

18V Li-Ion 4.0Ah battery provides more cycles per charge and charges in under 45 minutes



**Auto Retract**

Tool automatically retracts when the cutting cycle is complete

**350° Rotating Head**

Designed to cut at any angle

**Tacky Grip**

Gripping the tool is easier and more comfortable

**OLED Display**

Real-time communication and tool maintenance status

**Bluetooth® Communication**

Connect with i-Press® App to track tool performance



Work smarter and safer with the all new i-press smartphone app. Simply connect your next generation Greenlee Gator® tool to the i-press app via Bluetooth® to take advantage of tool performance, tracking and more.

**CU/AL ONLY. DO NOT USE WITH ACSR OR HARD METALS.**



**SPECIFICATIONS**

|                 | ESC50LX                                                                            |
|-----------------|------------------------------------------------------------------------------------|
| <b>Height</b>   | 21" (533 mm)                                                                       |
| <b>Width</b>    | 3" (76 mm)                                                                         |
| <b>Length</b>   | 4.5" (114 mm)                                                                      |
| <b>Weight</b>   | 7.2 lb (3.25 kg)                                                                   |
| <b>Capacity</b> | Cuts up to 2" diameter Copper (Cu)/ Aluminum (Al) Standard and Fine Stranded Cable |

| CAT NO.   | UPC NO.      | DESCRIPTION                                                       |
|-----------|--------------|-------------------------------------------------------------------|
| ESC50LX11 | 783310080060 | 50 mm Soft Metal Cable Cutter, 120V Charger, Two 4.0 Ah Batteries |
| ESC50LX12 | 783310080077 | 50 mm Soft Metal Cable Cutter, 12V Charger, Two 4.0 Ah Batteries  |
| ESC50LX22 | 783310080107 | 50 mm Soft Metal Cable Cutter, 230V Charger, Two 4.0 Ah Batteries |
| ESC50LXB  | 783310080053 | 50 mm Soft Metal Cable Cutter, Bare Tool Only                     |

Makita® is a registered trademark of Makita Corporation. Bluetooth® is a registered trademark of Bluetooth SIG



**NEW**

# ESC25LX

## IN-LINE ACSR AND GUY WIRE CUTTER

### Replaceable Blade Inserts

Long-lasting, replaceable aluminum conductor steel-reinforced (ACSR) cutting blades

### Scissor Style Head

Compact open jaw design allows for fast action with little to no cable deformation and rotating head is ideal for one-handed overhead cutting

### Double-Click Safety Feature

Helps prevent unintentional engagement of cutting jaw

### Improved Durability

Enclosed, impact-resistant, housing and coated circuit boards protect against water and dirt

### Makita® Battery Platform

18V Li-Ion 4.0Ah battery provides more cycles per charge and charges in under 45 minutes

### Bluetooth® Communication

Connect with i-press® App to track tool performance



ESC25LX



### CAPACITY

|                     |              |
|---------------------|--------------|
| Cutter Head Opening | 1" (25 mm)   |
| ACSR                | 557 kcmil    |
| Standard Guy Strand | 1/2" (12 mm) |
| EHS Guy Strand      | 3/8" (10 mm) |

### ESC25LX – SCISSOR STYLE

| CAT NO.   | UPC NO.      | DESCRIPTION                                          |
|-----------|--------------|------------------------------------------------------|
| ESC25LX11 | 783310084907 | 25 mm ACSR Cutter, 120V Charger, Two 4.0Ah Batteries |
| ESC25LX12 | 783310084914 | 25 mm ACSR Cutter, 12V Charger, Two 4.0Ah Batteries  |
| ESC25LX22 | 783310084921 | 25 mm ACSR Cutter, 230V Charger, Two 4.0Ah Batteries |
| ESC25LXB  | 783310084938 | 25 mm ACSR Cutter, Bare Tool Only                    |

### SPECIFICATIONS

|        |                |
|--------|----------------|
| Width  | 3" (76 mm)     |
| Height | 18.5" (470 mm) |
| Weight | 7 lb (3.17 kg) |



**NEW**

## EK628LX – 6-TON IN-LINE TOOL

GET MORE DONE WITH ONE TOOL

### Interchangeable Jaws

Providing versatility in cutting and crimping

### Patented Spring Pin

Easily and quickly change jaws

### Intelli-CRIMP® Technology

Allows for real time feedback on crimp force

### 350° Rotating Head

Designed to cut and crimp at any angle

### In-line Tool Style

Lightweight and very easy to control

### LED Work Light

Illuminates dark work areas



EK628LX



| CAT NO.   | UPC NO.      | DESCRIPTION                                                |
|-----------|--------------|------------------------------------------------------------|
| EK628LX11 | 783310609391 | 6 Ton Crimper, CJ22 Jaw, 120V Charger, Two 2.0Ah Batteries |
| EK628LX12 | 783310609407 | 6 Ton Crimper, CJ22 Jaw, 12V Charger, Two 2.0Ah Batteries  |
| EK628LX22 | 783310609414 | 6 Ton Crimper, CJ22 Jaw, 230V Charger, Two 2.0Ah Batteries |
| EK628LXB  | 783310609445 | 6 Ton Crimper, CJ22 Jaw, Bare                              |

### SPECIFICATIONS

|                |                                                      |
|----------------|------------------------------------------------------|
| Crimping Force | 6-Ton (54kN)                                         |
| Length         | 14-3/4" (375 mm) without head or battery             |
| Width          | 4" (108 mm)                                          |
| Weight         | 6.6 lb (3 kg)                                        |
| Battery        | 18V 4.0Ah Li-ion (EK425) or 18V 2.0Ah Li-ion (EK628) |

### CAPACITY

|                                 |                    |
|---------------------------------|--------------------|
| Cooper color-coded connectors   | 8 AWG to 600 kcmil |
| Aluminum color-coded connectors | 8 AWG to 350 kcmil |

Makita® is a registered trademark of Makita Corporation.

Bluetooth® is a registered trademark of Bluetooth SIG





**NEW**

# INTERCHANGEABLE CUTTING JAWS

## FOR EK628 AND EK425 6-TON BATTERY TOOLS

### Capacity

- Up to 477 kcmil Pelican
- Up to 5/16" Guy Strand (EHS)
- Up to 3/8" Guy Strand (HS)



CJ-ACSR1

### Hardened Blade

Produce clean, smooth cuts

### Interchangeable Jaws

Quickly and easily change jaws



CJ-CUAL

### Capacity

Up to 600 kcmil Cu/Al

### ADDITIONAL JAW SETS AVAILABLE



CJB



CJD3BG



CJD3



CJD30



CJK



CJXPJ

| JAW SET | DESCRIPTION                                                       |
|---------|-------------------------------------------------------------------|
| CJBC    | Cutting Jaws for disposable locks.                                |
| CJD3BG  | Crimping jaws with D and BG die grooves. Accepts W dies           |
| CJD3    | Crimping jaw with single D die groove – Snub Nose. Accepts W dies |
| CJD30   | Crimping jaw with D and O grooves                                 |
| CJK     | Crimping jaw with Kearney O die grooves                           |
| CJXPJ   | Crimping jaw with Nicopress X, P, and J die grooves               |

### SPECIFICATIONS (CJ-ACSR1)

|          |                                                                          |
|----------|--------------------------------------------------------------------------|
| Capacity | 477 kcmil Pelican ACSR<br>5/16" Guy Strand (EHS)<br>3/8" Guy Strand (HS) |
| Length   | 5.72 in                                                                  |
| Weight   | 2.45 lbs                                                                 |

### SPECIFICATIONS (CJ-CUAL)

|          |                 |
|----------|-----------------|
| Crimping | 600 kcmil Cu/AL |
| Length   | 5.47 in         |
| Weight   | 2.45 lbs        |

| CAT. NO. | UPC NO.      | DESCRIPTION               |
|----------|--------------|---------------------------|
| CJ-CUAL  | 783310082231 | CU/AL Cutter Jaw Assembly |
| CJ-ACSR1 | 783310082248 | ACSR Cutter Jaw Assembly  |



**NEW**

# C3 AUTOWHIP™

AUTOMATED INTELLIGENCE – MEASURING, NOTCHING AND CUTTING.

**Polycarbonate Shield**

View the cutting operation—also allows access for blade replacement

**Touch-screen Interface**

Quickly change between whip configurations

**Capacity**

Type AC (BX), MC Cable & FMC  
1/2"–1" OD Aluminum & Steel

**Precision Servo Controls**

For accuracy and repeatability

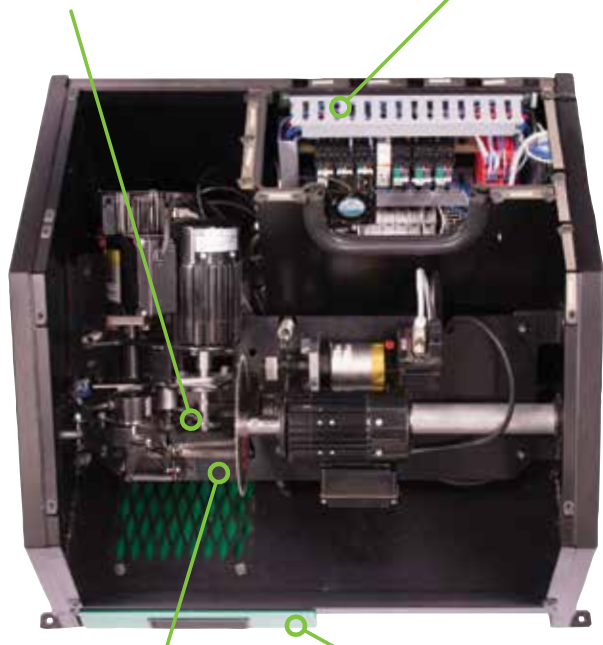

**USB Port**

Upload custom whip configurations & cable information

**Lockout/Tagout**

Improve safety by ensuring machine is de-energized during blade changes

**Setup & Walk Away**

Automated notching and cutting stations with automatic cable feed

**Removable Chip Tray**

Easily discard cutting debris

**SPECIFICATIONS**

|                      |                             |
|----------------------|-----------------------------|
| <b>Compatibility</b> | Type AC (BX), MC, & FMC     |
| <b>Cable Sizes</b>   | 1/2" – 1" OD                |
| <b>Dimensions</b>    | 27.3" W x 22.6" D x 19.1" H |
| <b>Weight</b>        | 170 lb (77 kg)              |

| CAT. NO. | UPC NO.      | DESCRIPTION                     |
|----------|--------------|---------------------------------|
| C3AW     | 783310073130 | C3 Auto Whip™ Clad Cable Cutter |



**NEW**

# BENDWORKS®

IT JUST KEEPS GETTING EASIER.

UP TO  
**40%**

Improved Fabrication  
Productivity

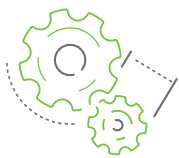

UP TO  
**35%**

Reduction in Scrap

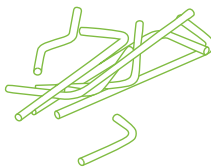

UP TO  
**80%**

Less Rework

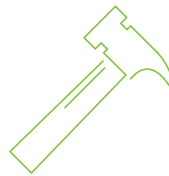

## Benefits Include:

### Error Checking

Verifies design against conduit bending rules and the Greenlee bender-specific parameters

### Material Optimization

Optimizes conduit runs for fewest cuts and segments

### Waste Reduction

Reduces the conduit bone pile and workflow inefficiencies

### Bill of Material Accuracy

Provides output files of required conduit length and removes guesswork from conduit bill of material

### Quality Control and Assurance

Retains run information automatically during changes

Details output of conduit segments with unique identification for traceability on the jobsite

### Automated Calculations for Bending Operator

Greenlee bender-specific output files provide bending instructions and reduce operator error

### Fully Integrated with Autodesk® Revit® and Revit® MEP

Supports collaboration between multiple design users, and allowing for compatibility back and forth between Autodesk® Revit® and BendWorks™



## BendWorks® FREE 30-DAY TRIAL

Download your free trial at Autodesk® App Store  
[apps.exchange.autodesk.com](https://apps.exchange.autodesk.com)

For more information, view BendWorks® videos at:  
[BendingRevolution.com](https://BendingRevolution.com)



**NEW**

# WORKHORSE™

## ALL-IN-ONE BENDING & THREADING WORKSTATION



### SPECIFICATIONS

|                      |                   |
|----------------------|-------------------|
| Height, with casters | 38" (965.2 mm)    |
| Width                | 32" (813 mm)      |
| Length               | 74" (1880 mm)     |
| Weight, WK100        | 440 lb (199.6 kg) |
| Weight, WK100-B      | 390 lb (17.9 kg)  |

| CAT. NO. | UPC NO.      | DESCRIPTION                                                                              |
|----------|--------------|------------------------------------------------------------------------------------------|
| WK100    | 783310077459 | Workhorse™ Bending and Threading Station (includes kit accessories)                      |
| WK100-B  | 783310078654 | Workhorse™ Bending and Threading Bare Cart (excludes all kit and additional accessories) |

**NEW**

# ALL-IN-ONE BENDING & THREADING WORKSTATION



**Additional Storage**

Open space to store hand tools and accessories



**Chain Vise Mounting Kit**

Easily install chain vise to secure conduit when cutting or threading



**Conduit Checking**

Get your pipe off the ground when checking your 90 degree stub-ups and marking measurements



**Oil Catch System**

Keep a clean work station using the Workhorse™ oil catch system\*



**Cord Organization**

Pass-through holes for increased control and easy electrical cord consolidation



**Compatibility**

555® Series Bender, 854DX Bender, 467 Chain Vise

**KIT ACCESSORIES – INCLUDED WITH WK100**

| CAT. NO. | UPC NO.      | DESCRIPTION                          |
|----------|--------------|--------------------------------------|
| CRSL8    | 783310078708 | 8" Caster Kit                        |
| MK555    | 783310077602 | 555® Bender Series Mounting Brackets |
| MKTC     | 783310077565 | Threader Mounting Brackets           |
| 90BC     | 783310077619 | 90 Degree Bend Check Tray            |
| MK467    | 783310077572 | Chain Vise Mount                     |

**ADDITIONAL ACCESSORIES AND EQUIPMENT – SOLD SEPARATELY**

| CAT. NO. | UPC NO.      | DESCRIPTION                                      |
|----------|--------------|--------------------------------------------------|
| MK85X    | 783310077596 | 854DX / 855GX Bender Mounting Brackets           |
| MKOIL    | 783310077589 | Oil Catch System                                 |
| CRSL6    | 783310078685 | 6" Caster Kit                                    |
| 555CXRS  | 783310016342 | Electric Bender, CX with Single Rigid Shoes      |
| 555RSC   | 783310016328 | Electric Bender, Classic with Single Rigid Shoes |
| 854DX    | 783310026709 | Bender, Electric Conduit                         |
| 855GX    | 783310125792 | Bender, Electric Conduit (855GX)                 |
| 467      | 783310273189 | Vise and Chain, Packaged                         |

\*Threaders Sold Separately



**NEW**

# SHEAR 30T

MAXIMIZE PRODUCTIVITY. FROM PREPARATION TO JOBSITE.



**Die Grooves**

Ensures the dies are inserted correctly every time

**Quick Die Change System**

Easily swap out dies with no tools or loose parts

**Automatic Retraction**

Retaining spring arm brings back dies into starting position for next cut

**Material Rest**

Keeps material perpendicular for clean cuts and extended die life

**Hydraulic Hose Through-Hole**

Contains hydraulic hose from the pump to the ram

**Powerful 30-Ton Hydraulic Ram**

Easily and quickly shears through tough material

**Hydraulically Powered**

Use with Greenlee 980 electric pump or EHP700L11 battery-powered pump

**Laser-Marked Measuring System**

Accurately shear each piece to precise length with movable arm and measuring stop



**SHEAR 30T KIT OPTIONS**

**COMPONENTS**

| CAT. NO.                                          | Bare Kit (GLSSB) | Kit with No Pump (GLSSKIT001) | Kit with 980 Pump (GLSS980KIT002) | Kit with EHP Pump (GLSSEHPKIT003) |
|---------------------------------------------------|------------------|-------------------------------|-----------------------------------|-----------------------------------|
| Shearing Unit                                     | X                | X                             | X                                 | X                                 |
| Mobile Cart                                       | X                | X                             | X                                 | X                                 |
| Measurement Arm                                   | X                | X                             | X                                 | X                                 |
| Dual Profile Strut Die (1-5/8" & 13/16" x 1-5/8") |                  | X                             | X                                 | X                                 |
| Threaded Rod Die (1/4", 3/8", 1/2", 5/8")         |                  | X                             | X                                 | X                                 |
| 980 Electric Hydraulic Pump                       |                  |                               | X                                 |                                   |
| EHP Battery Hydraulic Pump                        |                  |                               |                                   | X                                 |

**NEW**

# STRONG, DURABLE DIES

HIGH-GRADE STEEL ENSURES LONG LIFE



**158SSTRT**  
Dual-Profile Strut  
1-5/8" x 1-5/8" &  
1-5/8" x 13/16"



**158STRDSTRT**  
Strut  
1-5/8" x 1-5/8"



**78SSTRT**  
Strut  
7/8" x 1-5/8"



**1316SSTRT**  
Strut  
13/16" x 1-5/8"



**1458TROD**  
Threaded Rod  
1/4", 3/8", 1/2", 5/8"



**158DSTRT**  
Back to Back Strut  
1-5/8" x 3-1/4"



**78DSTRT**  
Back-to-Back Strut  
7/8"



**1316DSTRT**  
Back-to-Back Strut  
13/16"



**4STRT21**  
Cooper B-Line® Strut  
4D21 2-1/8" x 1-1/16"



**4STRT22**  
Cooper B-Line® Strut  
4D22 2-1/8" x 2-1/8"



**THDR7515**  
Top-Hat DIN Rail  
Combo Die  
7.5 mm & 15 mm x 35 mm



**GSDR15**  
DIN Rail – G-Section



**3000SSRB**  
Legrand 3000  
Series Raceway  
1-15/32" x 2-3/4" (Base)



**3000SSRC**  
Legrand 3000  
Series Raceway  
2-3/4" (Cover)

## OTHER DIE OPTIONS AVAILABLE (SOLD SEPARATELY)

| CAT. NO.    | UPC. NO.     | DESCRIPTION                                            |
|-------------|--------------|--------------------------------------------------------|
| 158SSTRT    | 783310082255 | Dual Profile (1-5/8" & 13/16" x 1-5/8")                |
| 1458TROD    | 783310082293 | Threaded Rod (3/8", 1/4", 1/2", 5/8")                  |
| 4STRT21     | 783310082279 | Cooper B-Line® 4D21 Strut                              |
| 4STRT22     | 783310082286 | Cooper B-Line® 4D22 Strut                              |
| 158STRDSTRT | 783310088424 | Strut – 1-5/8"                                         |
| 1316SSTRT   | 783310088417 | Strut – 13/16"                                         |
| 78SSTRT     | 783310510123 | Strut – 7/8"                                           |
| 158DSTRT    | 783310082262 | Back to Back Strut – 1-5/8"                            |
| 1316DSTRT   | 783310510130 | Back to Back Strut – 13/16"                            |
| 78DSTRT     | 783310510123 | Back to Back Strut – 7/8"                              |
| 3000SSRB    | 783310037347 | Legrand 3000 Series Raceway – 1-15/32" x 2-3/4" (Base) |
| 3000SSRC    | 783310037354 | Legrand 3000 Series Raceway – 2-3/4" (Cover)           |
| THDR7515    | 783310037521 | DIN Rail Combo Die – 7.5 mm & 15 mm x 35 mm            |
| GSDR15      | 783310037385 | DIN Rail – G Section                                   |

*B-Line is a registered trademark of Cooper Technologies Company*

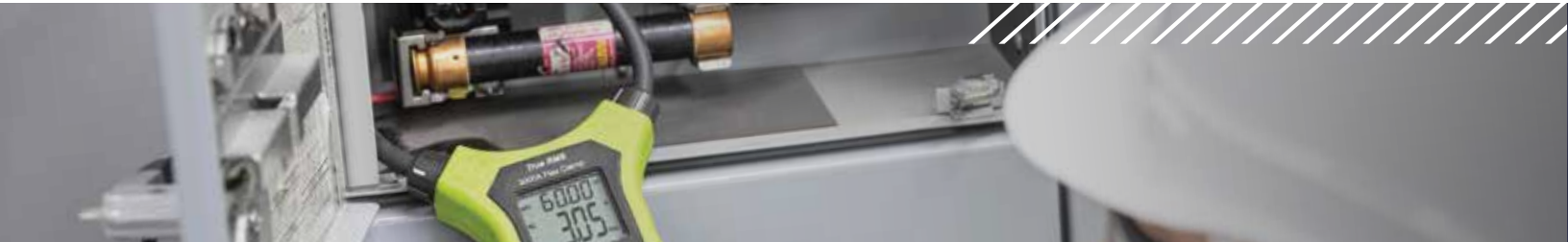

**NEW**

# FLEXIBLE CLAMP METERS

CMF-110, CMF-118, FC-110, FC-118



**10" and 18" Flexible Rogowski Coils**  
Capture measurements with flexibility

**Current Range Selector**  
Available ranges: 30A, 300A, 3000A

**LCD Screen**  
Displays measurement data and function modes

**Lock Mechanism**  
Easily secures coil for accurate measurement

**Banana Test Leads**  
Compatible with most meters that measure AC millivolts



CMF-110

FC-118

## CMF SERIES

## FC SERIES



### CMF SERIES SPECIFICATIONS

|                        |                                       |
|------------------------|---------------------------------------|
| Amperage Measurement   | 30.00, 300.0, 3000A AC                |
| Voltage Measurement    | 6.000, 60.00, 600.0V AC               |
| Resistance Measurement | 6.000, 60.00, 600.0kΩ; 6.000, 60.00MΩ |
| Frequency Measurement  | 20 to 30kHz                           |
| Coil Length            | 10" (25.4 mm), 18" (45.7 cm)          |
| Measurement Category   | CAT IV, 600V                          |

### FC SERIES SPECIFICATIONS

|                      |                              |
|----------------------|------------------------------|
| Current Measurement  | 30.0, 300, 3000A             |
| Coil Length          | 10" (25.4 mm), 18" (45.7 cm) |
| Measurement Category | CAT IV, 600V                 |

| CAT. NO. | UPC NO.      | DESCRIPTION                          |
|----------|--------------|--------------------------------------|
| CMF-100  | 783310088530 | 10" Flex Clamp Meter                 |
| CMF-118  | 783310088547 | 18" Flex Clamp Meter                 |
| CMF-LK   | 783310037569 | Test Lead Replacement Kit            |
| FC-110   | 783310088554 | 10" Flex Clamp Current Probe         |
| FC-118   | 783310088561 | 18" Flex Clamp Current Probe         |
| CMF-B    | 783310088790 | FC and CMF Replacement Carrying Case |





**NEW**

# 5124

## MOTOR ROTATION INDICATOR



**Over Molded Holster**  
Protects the meter from debris

**Phase Sequence Indicators**

**LED Motor Rotation Indicators**



5124



**SPECIFICATIONS**

|                                     |                                                      |
|-------------------------------------|------------------------------------------------------|
| <b>Voltage Range (Line-to-Line)</b> | Rotational field: 80V to 440V<br>Phase: 190V to 600V |
| <b>Frequency</b>                    | 50Hz to 60Hz                                         |
| <b>Battery</b>                      | 9V                                                   |
| <b>Safety Voltage Rating</b>        | Cat III, 600V                                        |

Accessories included: (2) red and black leads, (2) red and black test alligator clips, (1) black test probe and soft carrying case (with calibration certificate\*)

| CAT. NO. | UPC NO.      | DESCRIPTION                                      |
|----------|--------------|--------------------------------------------------|
| 5124     | 783310088752 | Phase Sequence Rotation Motor Indicator Kit      |
| 5124-LK  | 783310088776 | Tri-color Leads with Alligator Clips Replacement |
| 5124-B   | 783310088769 | Soft Carrying Case Replacement                   |

\*Calibrated only



**NEW**

# CIRCUIT SEEKER™ – CS-5000

TRACE AND LOCATE WITH CONFIDENCE



Accessories included: (2) alligator clips, AC blade, AC plug adapter, (2) extension leads, and carrying case

## SPECIFICATIONS

|                                        |                                                                                                                     |
|----------------------------------------|---------------------------------------------------------------------------------------------------------------------|
| Voltage Rating                         | 600V AC/DC                                                                                                          |
| Tracing Range Open Line Mode           | Up to 10 ft (3 m) with a metallic connection to ground; 1 to 3 ft (0.3 to 0.9 m) with a capacitive ground reference |
| Tracing Range Live Line Mode           | Up to 20 ft (6 m) from circuit                                                                                      |
| Auto Power Off Intervals (Transmitter) | 4 Hours                                                                                                             |
| Auto Power Off Intervals (Receiver)    | 30 minutes without signal                                                                                           |
| Battery Type                           | Transmitter – Two 1.5V AA batteries;<br>Receiver – Two 1.5V AA batteries                                            |

| CAT. NO. | UPC NO.      | DESCRIPTION         |
|----------|--------------|---------------------|
| CS-5000  | 783310085133 | Circuit Seeker Kit  |
| 08435    | 783310084358 | Transmitter         |
| 08436    | 783310084365 | Receiver            |
| 10057    | 783310100577 | (2) Alligator Clips |
| 10054    | 783310100546 | AC Blade            |
| 12852    | 783310128526 | AC Plug Adapter     |
| 12853    | 783310128533 | (2) Extension Leads |
| 08437    | 783310084372 | Carrying Case       |



**NEW**

# GROUND RESISTANCE TESTER

IMPROVE SAFETY. MAXIMIZE PRODUCTIVITY.



**Wide Jaw Opening**

Clamps around cable and rod diameters up to 1.38 inch

**Rotary Dial**

For easy selection of the variety of different settings

**Memory Function**

Stores up to 300 measurements

**Non-Contact Voltage Detection**

Visual and audible alerts for increased safety

**Automated Date and Time Stamp**

Facilitates accurate data reporting

**Large, Bright OLED Display**

Allows operator to read in low light conditions



CMGRT-100A



**SPECIFICATIONS**

|                                  |                             |
|----------------------------------|-----------------------------|
| Ground Resistance Measurements   | 0.01Ω to 1500Ω              |
| Current Measurement Frequency    | 47Hz to 800Hz               |
| Resistance Measurement Frequency | 2083Hz                      |
| Clamp Opening                    | 1.38"                       |
| Memory                           | 300 entries                 |
| Alarms (3)                       | Impedance, Voltage, Current |
| Weight                           | 2.06 lb                     |
| Measurement Category             | CAT IV, 600V                |

| CAT. NO.     | UPC NO.      | DESCRIPTION                          |
|--------------|--------------|--------------------------------------|
| CMGRT-100A   | 783310082217 | Ground Resistance Tester             |
| CMGRT-100A-C | 783310082224 | Ground Resistance Tester. Calibrated |
| CMGRT-CL     | 783310082200 | Calibration Verification Loop        |



**NEW**

# 5882A

## 1kV MEGOHMMETER



**Data Hold Button**  
Facilitates accurate capture of readings



**Convenient Kick Stand**  
Allowing the tester to be kept upright

**Non-Skid Over Molded Rubber Holster**  
Protects the meter against debris



5882A



**Molded in Magnetic Mount**  
For convenient hands-free measurements

**Large, Bright Digital Display**  
Allows operator to read in low light conditions

**Easy-to-use user interface**

**Rotary Selector**  
Select from the available 10 functions



### SPECIFICATIONS

|                        |                               |
|------------------------|-------------------------------|
| Pre-set Test Voltages  | 50V, 100V, 250V, 500V, 1000V  |
| Resistance Measurement | 0 to 4MΩ                      |
| Frequency Measurement  | 15.3 to 800Hz                 |
| Voltage Measurement    | .3 to 700V                    |
| Operating Temperature  | -4F to 131F                   |
| Storage Temperature    | -22°F to 176 °F               |
| Continuity Checking    | <100Ω                         |
| Standby Mode           | After 5 minutes of inactivity |
| Battery Power Supply   | Six 1.5V AA                   |
| Weight                 | 1.07 lb                       |
| Safety Voltage Rating  | Cat IV, 600V                  |

Accessories included: (2) red and black leads, (2) red and black test alligator clips, (1) black test probe and soft carrying case (with calibration certificate\*)

| CAT. NO. | UPC NO.      | DESCRIPTION                                                                                       |
|----------|--------------|---------------------------------------------------------------------------------------------------|
| 5882A    | 783310071549 | Megohmmeter 1kV                                                                                   |
| 5882A-C  | 783310084815 | Megohmmeter 1kV, Calibrated                                                                       |
| 5882A-LK | 783310085676 | Test Lead Kit (2) Red & Black Leads, (2) Red & Black Test Probes, (2) Red & Black Alligator Clips |
| 5882A-B  | 783310087762 | 1kV Soft Carrying Case                                                                            |

\*Calibrated only



**NEW**

# 5990A

## 5kV MEGOHMMETER



**Progressive Battery Gauge**  
Indicates the condition of the battery



**Detachable Lid**  
Enclosed with operating instructions



**Large Backlit LCD Display**  
Allows operator to read in low light conditions



**Handle and Shoulder Strap**  
Integrated into the unit for durable portability



**Five Pre-Set Test Voltages**  
250V, 500V, 1000V, 2500V, 5000V for quick adjustment



**All-In-One Carrying Bag**  
Designed with a heavy-duty zipper



### 5990A SPECIFICATIONS

|                                   |                                                                             |
|-----------------------------------|-----------------------------------------------------------------------------|
| Pre-set test voltages             | 250V, 500V, 1000V, 2500V and 5000V                                          |
| Voltage and Frequency Measurement | Up to 600V AC/DC                                                            |
| Automatic discharge               | Yes                                                                         |
| Battery Power supply              | 7.2V dc (6 × 1.2V nimhc size); rechargeable batteries with charger on-board |
| Auto-Calibration                  | Every time after turning power on                                           |
| Weight                            | 3 Kg without accessories, with batteries                                    |
| Safety Voltage rating             | Cat IV, 600V                                                                |

| CAT. NO. | UPC NO.      | DESCRIPTION                                                                                                                       |
|----------|--------------|-----------------------------------------------------------------------------------------------------------------------------------|
| 5990A    | 783310084716 | Megohmmeter 5kV                                                                                                                   |
| 5990A-C  | 783310084822 | Megohmmeter 5kV, Calibrated                                                                                                       |
| 5990A-LK | 783310087281 | Test Lead Kit Nylon Bag, (1) Red Lead with Alligator Clip, (1) Black Lead with Alligator Clip, (1) Green Lead with Alligator Clip |
| 5990A-B  | 783310087380 | 5kV Carrying Case                                                                                                                 |
| 5990A-M  | 783310088103 | Mains Cord                                                                                                                        |



**NEW**

# V-WATCH®

## PERSONAL VOLTAGE DETECTOR



### SPECIFICATIONS

|                                    |                                                                                                                            |
|------------------------------------|----------------------------------------------------------------------------------------------------------------------------|
| <b>Sensitivity</b>                 | The detector will only detect AC voltage; do not use below 2400VAC                                                         |
| <b>Typical Warning Distance</b>    | About 7' (2.13 m) from a 4kVAC conductor (2.4kV line-to-ground)<br>Refer to manual for more details                        |
| <b>Operating Voltage Ranges</b>    | 2400VAC and above<br>The detector will only detect AC voltage; do not use below 2400VAC                                    |
| <b>Operating Frequency</b>         | 50/60Hz                                                                                                                    |
| <b>Battery</b>                     | 3 AAA field replaceable lithium or alkaline batteries                                                                      |
| <b>Battery Life</b>                | 2 years in storage; 6 months of continuous use                                                                             |
| <b>Operating Temperature Range</b> | -20°F to +120°F (-29°C to +49°C)                                                                                           |
| <b>Weight (With Batteries)</b>     | 7.97 oz (0.23 kg)                                                                                                          |
| <b>Dimensions</b>                  | Closed: 5.53" x 3.54" x 1.42"<br>(14.0 cm x 9.0 cm x 3.6 cm)<br>Open: 6.29" x 3.54" x 1.42"<br>(15.9 cm x 9.0 cm x 3.6 cm) |



| CAT. NO. | UPC. NO.     | DESCRIPTION                                         |
|----------|--------------|-----------------------------------------------------|
| VWS-20   | 783310081364 | V-Watch Personal Voltage Detector with VW-S-BAG Bag |
| VW-S-BAG | 783310088288 | Replacement Padded Carrying Bag with Drawstring     |



**NEW**

# LOOKOUT® VOLTAGE DETECTION NETWORK WITH HDE LOOKOUT APP

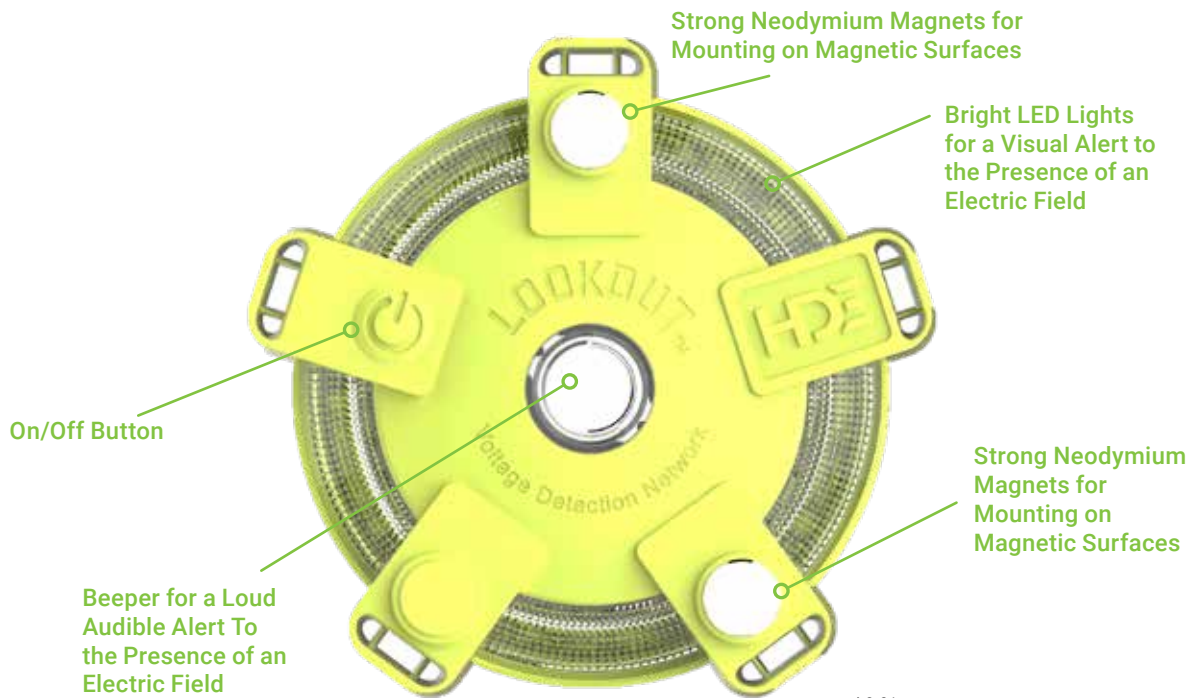

LO-01



## SPECIFICATIONS

|                                  |                                                                                                |
|----------------------------------|------------------------------------------------------------------------------------------------|
| <b>Voltage Range</b>             | System voltage from 4kVAC to 500kVAC – Do not use below 2400VAC line-to-ground                 |
| <b>Operating Frequency</b>       | 50/60Hz                                                                                        |
| <b>Typical Warning Distance*</b> | Approx. 3 ft (91 cm) from a 4kVAC conductor – For more details refer to the instruction manual |
| <b>Communication Range</b>       | Up to 100 ft (30 m) between detectors                                                          |
| <b>Weight</b>                    | 1 lb (0.45 kg) single detector                                                                 |
| <b>Dimensions</b>                | 6.75" Ø x 1.55" H (17.14 cm x 3.94 cm)                                                         |
| <b>Enclosure Rating</b>          | IP67                                                                                           |

\*Based on OSHA standard 1910.269 for minimum approach distances for qualified electrical workers

| CAT. NO. | UPC. NO.     | DESCRIPTION                                                                             |
|----------|--------------|-----------------------------------------------------------------------------------------|
| LO-01    | 783310045175 | LOOKOUT Voltage Detector                                                                |
| LO-OP    | 783310045182 | LOOKOUT Operator Unit – Relays network alerts to the operator (Does NOT detect voltage) |
| LOC-01   | 783310045243 | LOOKOUT Charger, 12V                                                                    |
| LO-EM    | 783310045250 | Equipment Mount                                                                         |
| LO-CL    | 783310045328 | Claw Tool for Detector Installation                                                     |
| LO-CB    | 783310045335 | Safety Cone Mounting Bracket                                                            |
| LO-HB    | 783310045397 | Fence Hanger Bracket                                                                    |
| LO-XF1   | 783310556602 | Charger Adapter, 120V                                                                   |
| LO-XF2   | 783310556619 | Charger Adapter, 220V                                                                   |
| LO-BGS   | 783310045410 | Carrying Bag                                                                            |



MA6612 rev 9/19

4455 Boeing Dr • Rockford, IL 61109 • USA • 800-435-0786  
©2019 Greenlee Tools, Inc. • An ISO 9001 Company • Printed in USA

GREENLEE.COM



Professional. Nothing Less.™

